

Top 10 Reasons to Upgrade to Windchill® 10.0

With powerful new capabilities for managing and validating product configurations plus a new user experience and improved system administration, Windchill 10.0 is now easier than ever to use and maintain, allowing broader adoption and greater value realization.

Here are the top ten reasons why upgrading to Windchill 10.0 can benefit your organization:

1. Do more: Breadth of capabilities

Windchill 10.0 extends PTC’s PLM solution to support critical after-market business processes by repurposing real-time product development and engineering bill-of-materials (eBOM) data to create and manage product-centric technical information and service bills-of-materials (sBOMs). This expanded capability enables customers to deliver configuration-specific service information—including dynamic parts lists, maintenance procedures, training materials and operator instructions—that can improve product and service performance throughout the product lifecycle.

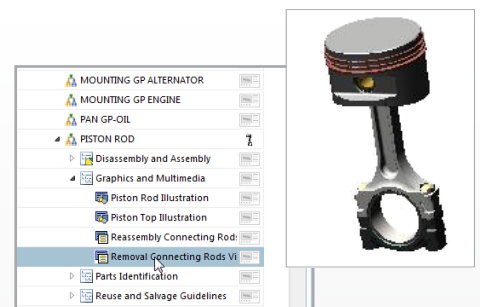

2. Do more: Depth of capabilities

Windchill 10.0 brings MCAD and ECAD closer together by offering one user experience for both mechanical and electrical engineers. New ECAD workgroup management capabilities include more tools, wizards and a tighter association with the product configuration. These new capabilities make additional engineering data—such as schematic drawings, PCB layouts and wire harnesses—accessible anytime, anywhere, across all teams and organizations.



3. Do more: Process-related capabilities

Windchill 10.0 simplifies and streamlines key product development processes for companies of all sizes. Using top-down design, engineers can create and/or modify CAD assemblies directly within Windchill, outside of the CAD environment. New design-in-context capabilities provide designers with a powerful tool that can reduce and even eliminate the need to work with large top-level assemblies. Windchill 10.0 can enforce logic and rules to control the interdependencies of configurations within a product family. In addition, Windchill 10.0 offers a new optional module, Windchill Interference Management Service, to automatically detect, manage and report on interferences in 3D product models.

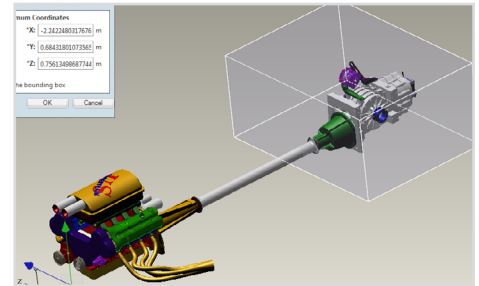

4. Know more: Product Cost

A new optional module in Windchill 10.0, Windchill Cost, makes product cost analytics an integral part of the standard product development process. This approach not only creates accurate, up-to-date cost reports, but also allows cost analysis to be performed on every product design change. This capability helps ensure that products are launched at or below target costs by providing real-time visibility of target and estimated costs to all stakeholders.

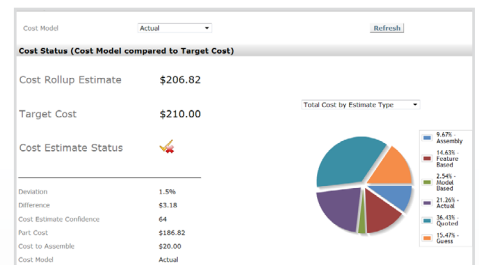

5. Know more: Product Quality

A new suite of optional Windchill modules all focus on Quality Lifecycle Management. Windchill Quality Solutions offer a systematic, enterprise-wide approach to ensure a product meets the requirements defined for it over the course of its development. By managing all the quality-, reliability- and safety-related processes that take place throughout the product development lifecycle, Windchill Quality Solutions communicate important quality information across the various teams within an enterprise. Furthermore, by compiling best practices and lessons learned, Windchill Quality Solutions help streamline product development, accelerate innovation and improve next-generation products—while simultaneously reducing the cost of poor quality by preventing repeat errors and building reliability and risk management into the product development lifecycle.

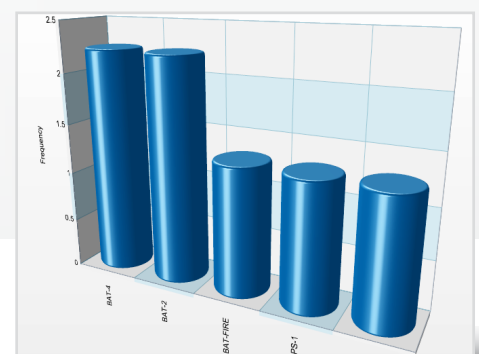

6. Know more: Product compliance and environmental impact

Windchill Product Analytics modules provide current, accurate visibility of product performance based on the actual product data while automating the traditionally time-consuming processes of data capture, BOM roll up and reporting. This capability enables companies to gain early visibility into product performance across multiple dimensions, such as environmental compliance, carbon emissions, weight and other critical performance factors. By building product performance analytics into the earliest phases of product development—when decisions have the greatest impact on product cost and are the least disruptive to the overall development schedule—companies can save money, drive product innovation and deliver products to market faster.

BOM Compliance Status: Based on current Part Qualification status selection:

Compliance Status: ✓ ✓ ✓

Compliance Specification: ✓ RoHS (C) ✓ RoHS (I) ✓ RoHS (S)

Revision: C C C

Company Part Summary		
	With Material Content Disclosure	Without Material Content Disclosure
Total Parts	1	7
✓ Pass	1	7
✗ Pass With Exemptions	0	0
✗ Partial Fail	0	0
✗ Fail	0	0
⊖ No Data	0	0
⊖ Not Applicable	0	0

7. Get more: Easier to learn

The Windchill 10.0 user experience has a cleaner look and feel that reduces the learning curve. This is particularly helpful to the “casual” PLM users (e.g., team members in sales, marketing, procurement, etc.) who only occasionally access Windchill and thus do not have the inclination to devote much effort in learning how to use a PLM system. With the short learning curve of Windchill 10.0, it’s now easier to expand or accelerate the roll out of a single PLM solution to the extended product development organization within the enterprise.

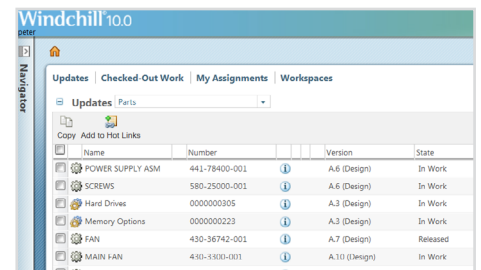

8. Get more: Easier to use

By closely working with our customers and User Experience experts, PTC has designed Windchill 10.0 to offer a dramatically improved and modernized experience. The cleaner look and feel allows users to quickly navigate, initiate tasks and configure the user interface according to their specific needs. Now, only the information relevant to a particular engineer is displayed in the order preferred.

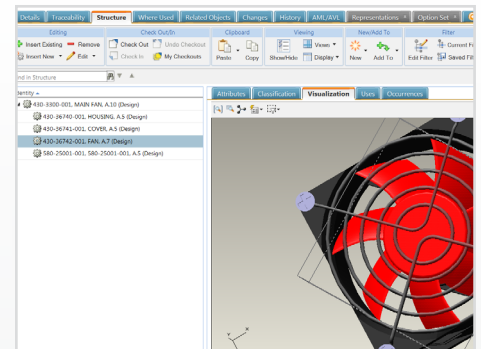

9. Get more: Easier to maintain

Windchill 10.0 offers improved monitoring and troubleshooting capabilities with tools to help optimize numerous IT and business administrative processes. With new performance—monitoring tools and improvements such as a streamlined upgrade and an easier installation process, manufacturers of all sizes realize greater value from their PLM investment while enjoying lower administration costs.

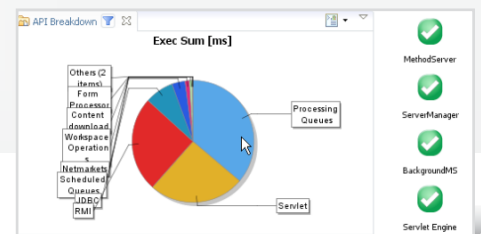

10. More resources to fully leverage the power of Windchill 10.0

PTC has expanded the number of tools and resources to help you quickly and thoroughly learn about Windchill 10.0:

- **Explore** – The [Windchill 10.0 Interactive Experience](#) allows you to see, experience and learn about Windchill 10.0 through videos, demonstrations and other resources
- **Discuss** – Join the conversation with other Windchill users at [PlanetPTC™ Community](#) to discover more about Windchill 10.0
- **Learn** – Learn from the experts at PTC University with role-based [courses](#) that are offered online as well as in classrooms around the world. You can also visit the [LearningExchange](#) for free tutorials created by PTC product experts.



PTC® university

Windchill 10.0–The most significant Windchill release in PTC’s history.

For executives, engineering managers and members of product teams seeking to better manage the complexities of product development, Windchill 10.0 can improve your business processes and productivity so that more products can be developed and shipped than ever before. Windchill 10.0 offers powerful new capabilities that allow you to do more with regard to the configuration, validation and control of product structures—from engineering through after-market servicing. Companies can now know more about their products’ performance with new modules that focus on product analytics and quality management. In addition, with a new user experience and powerful new administration tools, customers can get more value out of their PLM investments.

©2011, Parametric Technology Corporation (PTC). All rights reserved. Information described herein is furnished for informational use only, is subject to change without notice, and should not be construed as a guarantee, commitment, condition or offer by PTC. PTC, the PTC logo, Windchill, PlanetPTC and all PTC product names and logos are trademarks or registered trademarks of PTC and/or its subsidiaries in the United States and in other countries. All other product or company names are property of their respective owners. The timing of any product release, including any features or functionality, is subject to change at PTC’s discretion.

6763–Top 10 reasons to upgrade to Windchill® 10.0–TS–EN–0711